

# MDT 500-34

## Mill Duty Thruster Brake

### Introduction

Thruster Brake is a device to retard the speed of moving machinery and to stop it accurately to the desired position. The braking force is applied to the brake shoes by a pre-stressed compression spring.

The shoes press on the rotating brake drum retarding its speed, and finally stopping it. Other release devices like pneumatic / hydraulic cylinder or manual release arrangements can be offered on request.

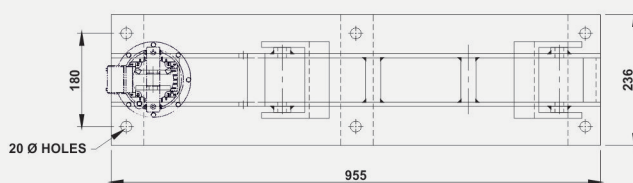
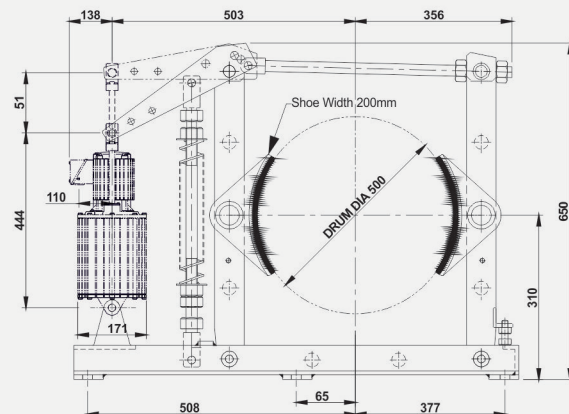
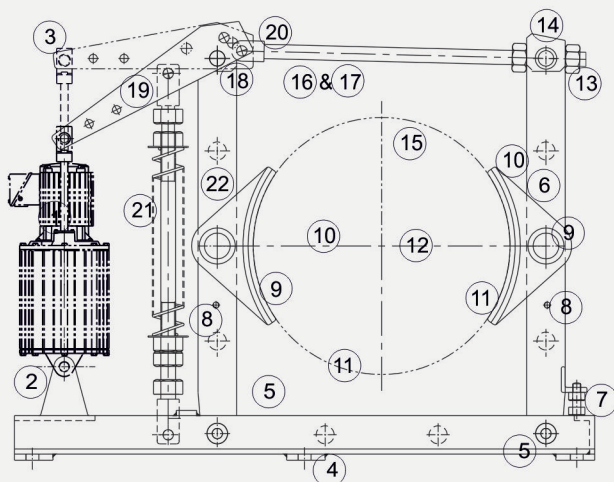
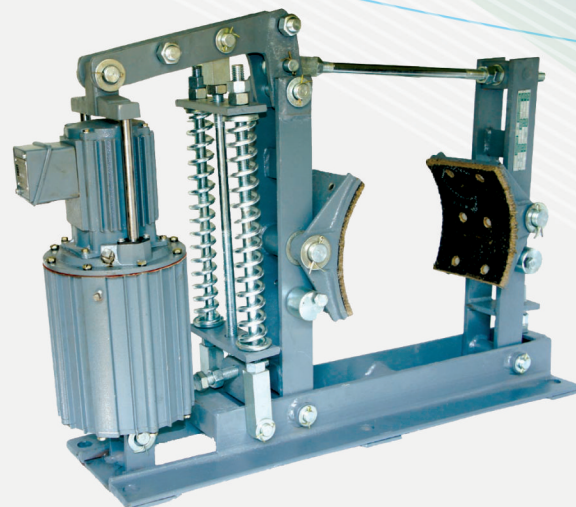

- |                                     |                                       |
|-------------------------------------|---------------------------------------|
| 1. Thruster assembly                | 13. Tie-rod adjustment nut & lock-nut |
| 2. Thruster Hinge pin (lower)       | 14. Swivel Block                      |
| 3. Thruster Hinge Pin (Brake lever) | 15. Tie rod or, connecting rod        |
| 4. Base Plate                       | 16. Swivel block for lever            |
| 5. Foundation bolt holes            | 17. Tie rod Hinge pin                 |
| 6. Side Arm                         | 18. Lever hinge pin                   |
| 7. Side Arm stopper screw           | 19. Lever                             |
| 8. Shoe adjusting screw             | 20. Brake Torque Adjustment nuts      |
| 9. Shoe hinge pin                   | 21. Compression Spring                |
| 10. Brake shoe                      | 22. Main Arm                          |
| 11. Brake liner                     |                                       |
| 12. Brake Drum (User's supply)      |                                       |

Brake Model	Item Code	Brake Drum Dimension (mm)	Braking Torque (kg-m)	Thruster Details		Stroke (mm)	Supply Volts At 50 Hz (V)	Oil Capacity (Litres)	* Mass (kg)
				Model	Lifting Force (kg)				
MDT - 500/34	100100080001	500	110	ST 535	34	50	415	2.5	125

Supply Voltage 380/480/550/690V available on request

(\* ) without thruster



### Speed-O-Controls Pvt. Ltd.

H. O. Unit - I : C-15/16, Nand Jyot Industrial Estate, Andheri-Kurla Road, Mumbai - 400072,  
 Tel : (022) 42469700-30, 28518512-3-4,  
 Fax : (022) 42469797/ 28518516,  
 E-mail : sales@socgroup.in

Unit - II: Plot No. 4912, G. I. D. C., Phase IV, Vatva, Ahmedabad - 382445  
 Tel.: (079) 40083201/2/3/4,  
 Fax : (079) 25841056,  
 E-mail : sales.amd@socgroup.in

Visit us at :  
[www.speedocontrols.com](http://www.speedocontrols.com)  
[www.socremote.com](http://www.socremote.com)