

Eldro 80/6

Eldro Thruster

Performance Features

- Compact, light weight & elegant design
- Reliable & maintenance free operation.
- Smooth jerk free perfectly linear motion.
- Low noise & does not emit electrical disturbances.
- IP-55, IP-65 degree of protection
- Suitable for out-door installation
- Low power input
- Upto 720 operations per hour.
- Easy mounting and dismounting
- Bi-directional operation.
- Immune from external over-loading
- Immune from supply voltage variations.
- Class F insulation scheme
- Windings for any voltages upto 600VAC 3Ø

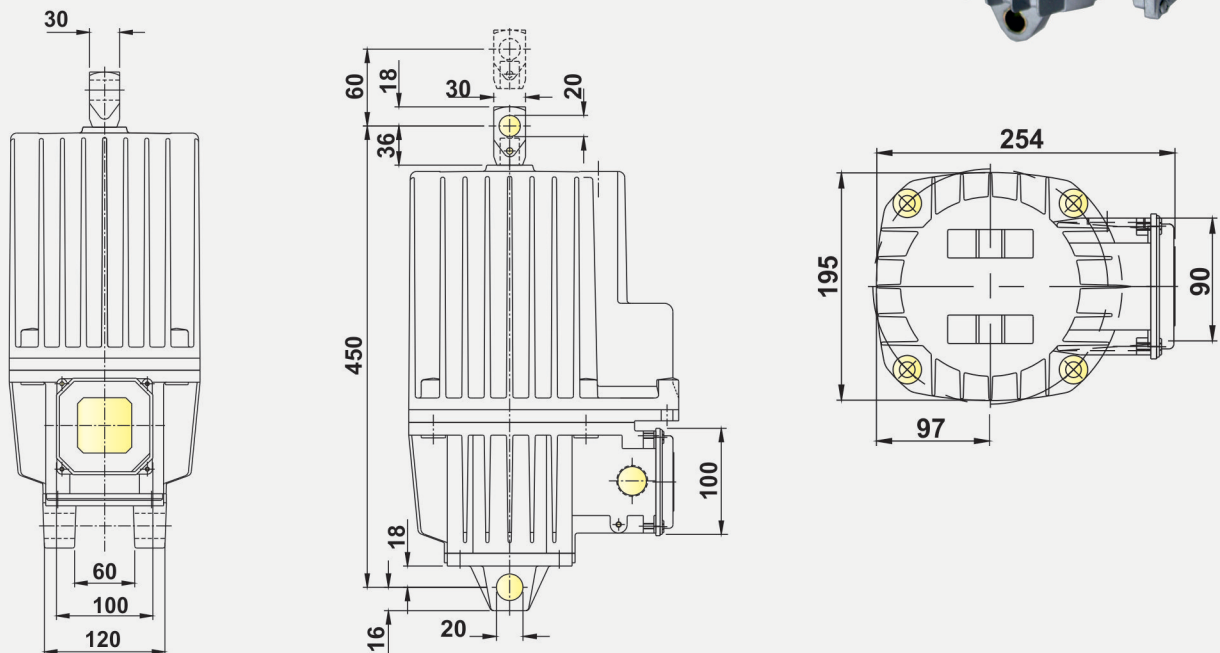

Thruster Model	Item Code	Lifting Force		Stroke (mm)	Supply Volts At 50Hz (V)	Input Watts (W)	Oil Capacity (Litres)	Wt. (kg)
		(kg)	(N)					
ELD 80/6	10050013001	80	800	60	415	330	4.2	25

Supply Voltage 380/480/550/690V available on request.



Speed-O-Controls Pvt. Ltd.

H. O. Unit - I : C-15/16, Nand Jyot Industrial Estate, Andheri-Kurla Road, Mumbai - 400072 ,
 Tel : (022) 42469700-30, 28518512-3-4,
 Fax : (022) 42469797/ 28518516,
 E-mail : sales@socgroup.in

Unit - II: Plot No. 4912, G. I. D. C., Phase IV, Vatva, Ahmedabad - 382445
 Tel.: (079) 40083201/2/3/4,
 Fax : (079) 25841056,
 E-mail : sales.amd@socgroup.in

Visit us at :
www.speedocontrols.com
www.socremote.com