

Brake Caliper HS 075 FHM

spring activated – hydraulically released
for wind turbines or conveyor systems

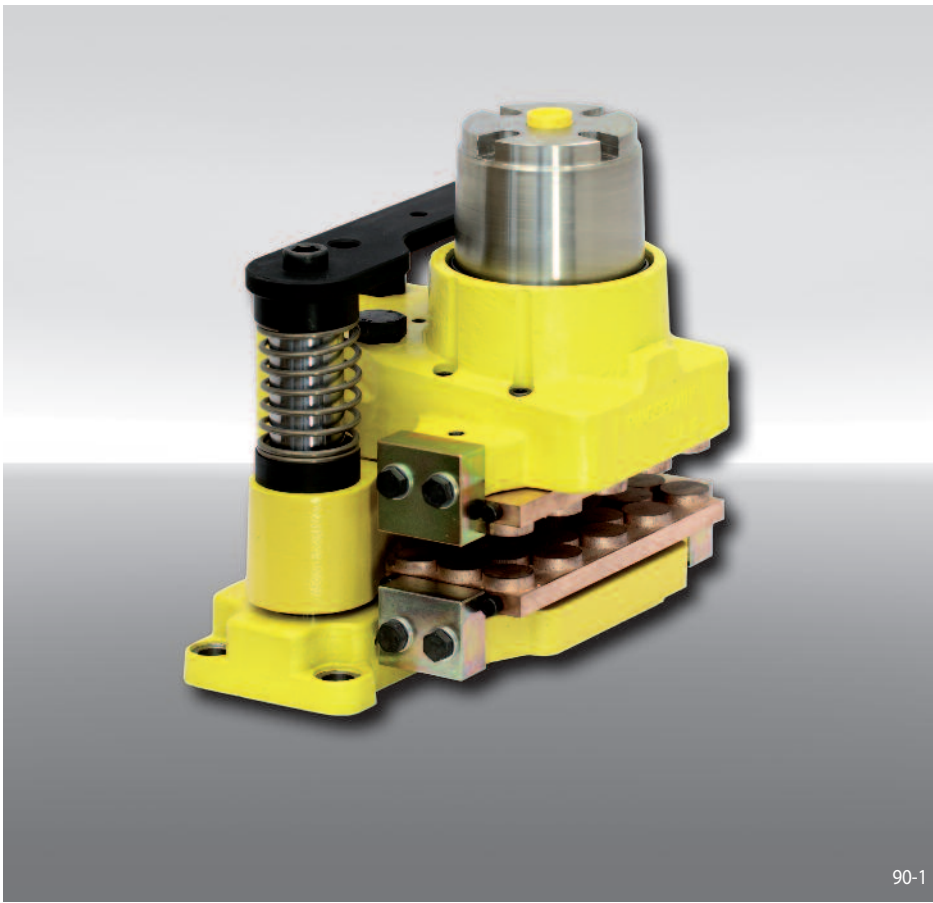

Features	Code
Brake Caliper	H
Floating caliper	S
With piston diameter 75 mm	075
Spring activated	F
Hydraulically released	H
Manual adjustment to accommodate friction block wear	M
Spring packages available for clamping forces of 10 kN, 20 kN, 30 kN, 40 kN or 55 kN	010 to 055

Example for ordering

Brake Caliper HS 075 FHM, spring package for clamping force 10 kN:

HS 075 FHM - 010

Technical Data

	Brake Caliper HS 075 FHM				
	with spring package 010	with spring package 020	with spring package 030	with spring package 040	with spring package 055
Brake disc diameter	Braking torque	Braking torque	Braking torque	Braking torque	Braking torque
mm	Nm	Nm	Nm	Nm	Nm
520	1500	3000	4400	5900	8100
630	1900	3800	5700	7600	10400
710	2200	4400	6600	8800	12100
900	3000	5900	8900	11900	16300
1250	4400	8700	13100	17500	24000
1600	5800	11500	17300	23100	31800
2000	7400	14700	22100	29500	40500
Clamping force	10 kN	20 kN	30 kN	40 kN	55 kN
Oil pressure	min. 25 bar max. 140 bar	min. 50 bar max. 140 bar	min. 70 bar max. 140 bar	min. 95 bar max. 140 bar	min. 125 bar max. 140 bar
Oil volume	max. 82 cm ³	max. 82 cm ³	max. 82 cm ³	max. 82 cm ³	max. 82 cm ³
Weight	95 kg	95 kg	95 kg	95 kg	95 kg

The braking torques shown in the table are based on a theoretical friction coefficient of 0,4.

Brake Caliper HS 075 FHM

spring activated – hydraulically released
for wind turbines or conveyor systems

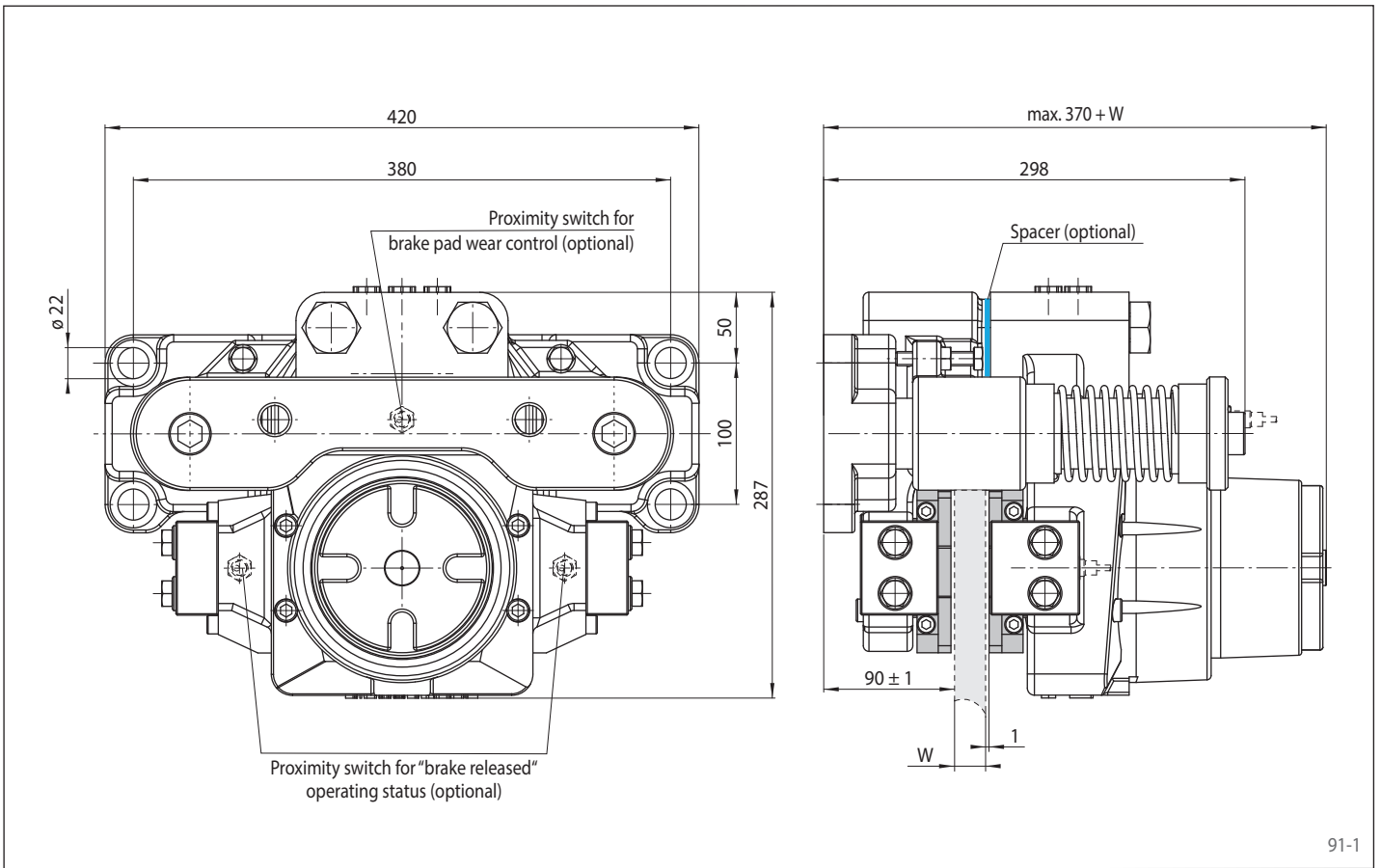

91-1

Mounting

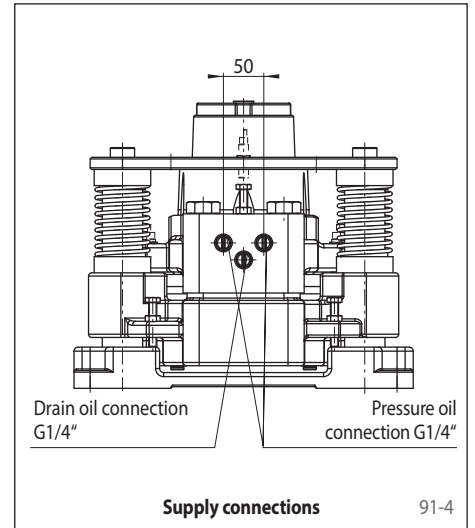
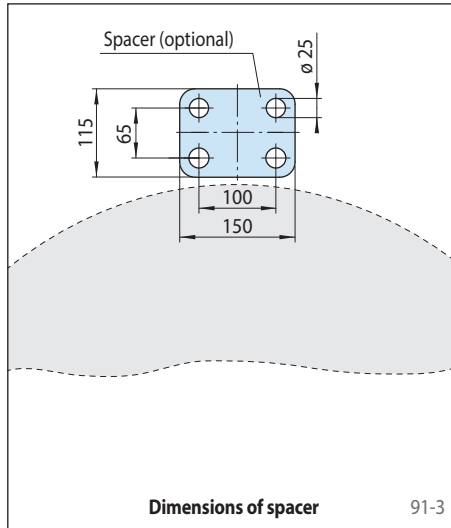
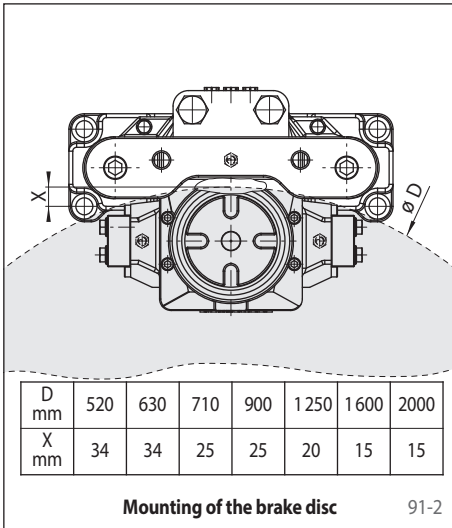

Other features

- High safety against leakage
- Easy change of friction blocks
- Painted with surface coating class C4-L according to ISO 12944
- For brake disc thickness $W = 20$ mm; brake disc thicknesses of up to 40 mm can be achieved with the use of a spacer installed by the customer

Accessories

- Inductive proximity switch for "brake released" operating status
- Inductive proximity switch for brake pad wear control
- Optional painting with surface coating class C4-H or C5M-H (offshore) according to ISO 12944