

GRLS/48/4SH

Rotary Geared Limit Switches GRLS

Introduction

Rotary Geared Limit Switch GRLS is used to trip motor supply when the moving loads reach the extreme end positions of working zone. The driving motion is transmitted by worm gear through worm shaft. The rotations & movements are transmitted to switches by adjustable cams.

Application

A Rotary Geared Limit Switches are suitable for use on reversing drives such as Hoists, winches Rolling Mills & various other mechanisms used in steel plants such as Coke Oven Feeding Machinery.

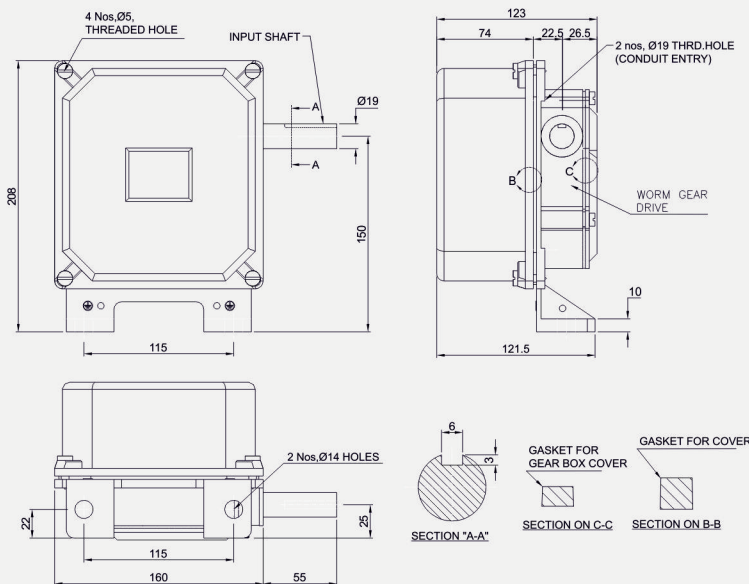

Technical Data

Body Material	Aluminium Die Cast
Protection Degree	IP-55 Confirming to IS-13947 (Part-1)1993
Gear Ratio	48:1
Drive	Worm Drive
Cable Entries	2X3/4* Conduit
Contact Material	Silver Cadmium
Rated Voltage Insulation	5000 V.A.C.
Thermal Test Current	40 Amps
No. Of Contacts	2NC + 2NO
Cam Setting	Adjustable

Mechanical Data

Ratios	Effective Rotations	Useful Rotations	2 Contacts Model
48:1	48	40	GRLS/48/4SH

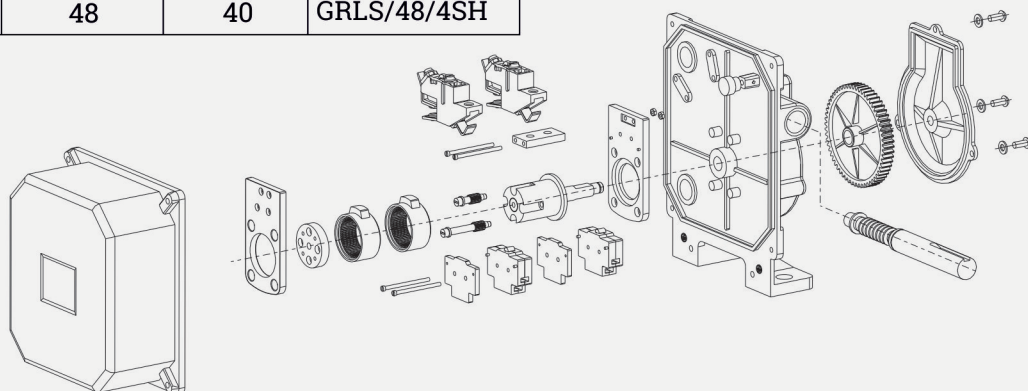

Speed-O-Controls Pvt. Ltd.

H. O. Unit - I : C-15/16, Nand Jyot Industrial Estate, Andheri-Kurla Road, Mumbai - 400072,
Tel : (022) 42469700-30, 28518512-3-4,
Fax : (022) 42469797/ 28518516,
E-mail : sales@socgroup.in

Unit - II : Plot No. 4912, G. I. D. C., Phase IV, Vatva, Ahmedabad - 382445
Tel.: (079) 40083201/2/3/4,
Fax : (079) 25841056,
E-mail : sales.amd@socgroup.in

Visit us at :
www.speedocontrols.com
www.socremote.com